

ADVANCE EMI / RFI FILTERS

INTRODUCTION:

Rapid changes of current cause generation of Radio Frequency Interference (RFI) noise. This may be due to Electronic switching such as Oscillators, SMPS, Triac Switches or Electromechanical switches such as commutators or Slip rings. Interference appearing across the line is called Differential Mode and the one appearing across the line to earth is called Common mode Interference. The RFI range covers the spectrum from 150KHz to 300MHz while the ElectroMagnetic Interference (EMI) covers from 10KHz to 10GHz.

APPLICATIONS :

RFI/EMI filters are used to reduce or to eliminate the unwanted RFI noise from entering or leaving the equipment. The suppression is carried out by connecting an inductance (High impedance to RF) in series or a capacitance (low impedance to RF) to ground. The ability of a filter to eliminate the noise is measured in terms of Insertion Loss (in dB) over a frequency spectrum. The RFI filters are used in Office Equipment, Communication Equipment, Instruments, Medical Instruments, SMPS, Computer peripherals, Thyristor Drives and Defence equipment.

SELECTION

The major parameters to be considered during the selection of a filter are :

Rated Voltage, Rated Current, RF noise spectrum, Level of suppression, Grounding arrangement and the leakage current.



Registered Office and Factory:

Advance Components and Instruments Pvt Ltd

3A-3A/1, Belavadi Industrial Area ,Mysore – 570018 KARNATAKA

Phone: +91 821 2402301 / 2402307 /2403058

Mobile & WhatsApp: +91 8073111025

E-mail : advcaps@gmail.com / enquiries@advancecapacitors.com

Website: www.advance-capacitors.com

ADVANCE EMI / RFI FILTERS

General Specifications:

Rated Voltage : 200-250Vac 50/60Hz
Rated Current @25°C : As specified in chart (Page #3)
Related Standards : VDE0565-1,2,3, BS2135, UL1283
IEC384-14, IEC939-1,1 JSS53900

Routine Tests

Electrical : Coils: Inductance +50%-30% (VDE 0565-03)
Capacitance: Cx: ±20% (IEC 384-14 X2)
Capacitance: Cy: ±20% (IEC 384-14 Y)
Attenuation : (IL in dB) as specified in drawing

Dielectric Strength : 1500Vac 50Hz for 1 minute (terminals to case)
1075Vdc for 1 second (terminal to terminal)
Insulation Resistance : Between terminals shorted and case
Min.1000MΩ at 500Vdc

Type tests

Voltage drop : Less than 1.5Volts at full load
Temperature Rise : at full load, less than 60°C above 25°C
by resistance method

Environmental

Temperature Cycling : JSS50101-Test 20
Life : JSS50101-Test 13, 250 hours
Damp Heat : 45°C 95% RH 500 hours

All electrical parameters (including Insertion loss) to be checked after the completion of the test.
All parameters to be within the initial specifications.

Resistance to Chemicals : Unit covered with black Toner in a chamber at 45°C for
120 hours. Toner should not stick to the surface.

ADVANCE Product Range:

Advance product range covers the full spectrum of RFI and EMI upto 1GHz, for DC or AC power line Voltages, from 1A to 400A current range. Various mounting arrangements such as clamp, PCB type, Flange, Bottom stud and various terminal arrangements are available. Integral socket type filters are also available.

ADVANCE EMI / RFI FILTERS

Single Phase 250Vac Filters

Type	Rating in Amperes	Packing, Size in mm	Application
AF-110-3,6 Single stage	3A, 6A	38*50/55 Aluminum Can with flexible wires	General Purpose
AF-111-8,10 Single stage	8A, 10A	38*70 Aluminum can with snap-on terminals	Photocopiers
AF-322-3,6 Single stage	3A, 6A	20*30*55 IEC Socket	Medical equipment
AF-3898-3 Single stage	3A	IEC socket	Medical equipment
AF-422-3 Single stage	3A	16*30*52 Flat aluminum can with snap-on terminals	Weighing machines
AF-612-8,10,15,30,40 Single & double stage	8A, 10A, 15A, 30A, 40A	40*80*104 Metal Box with screw or snap-on terminals	Power Supplies

DC Filters

Type	Rating in Amperes	Packing, Size in mm	Application
AF-612-2	2A 650Vdc	43*95*125 metal box with screw terminals	Medical equipment
AF-612-5	5A 800Vdc	41*80*107 Metal box with screw terminals	Medical equipment

AF-110-3

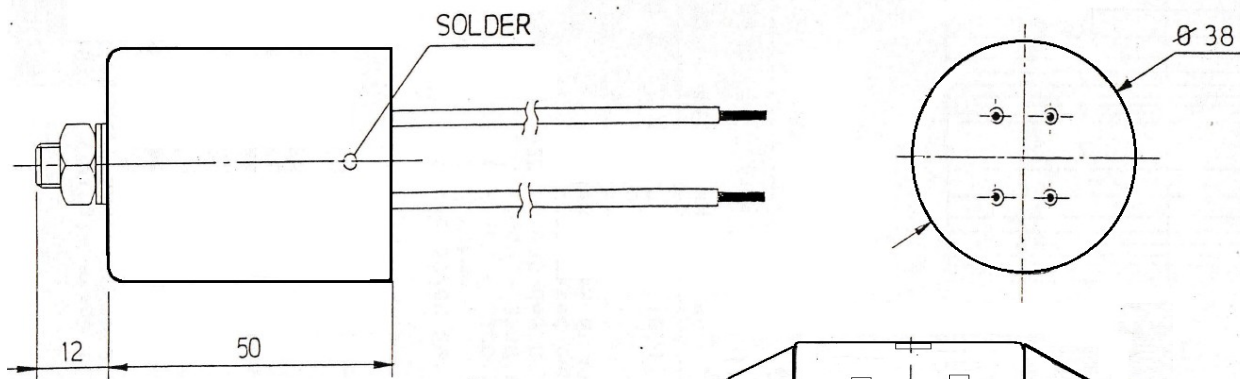

AF-322-3

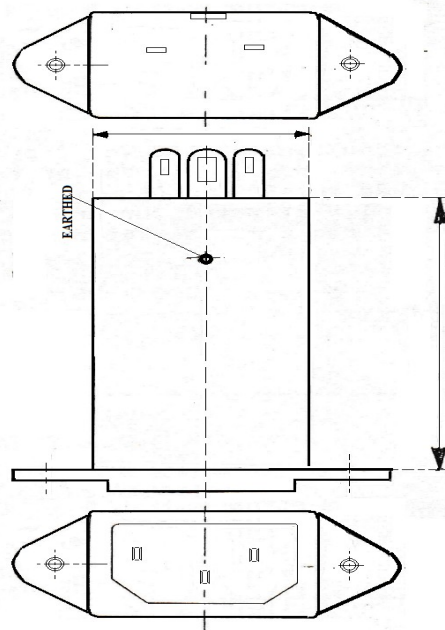

AF-3898-3

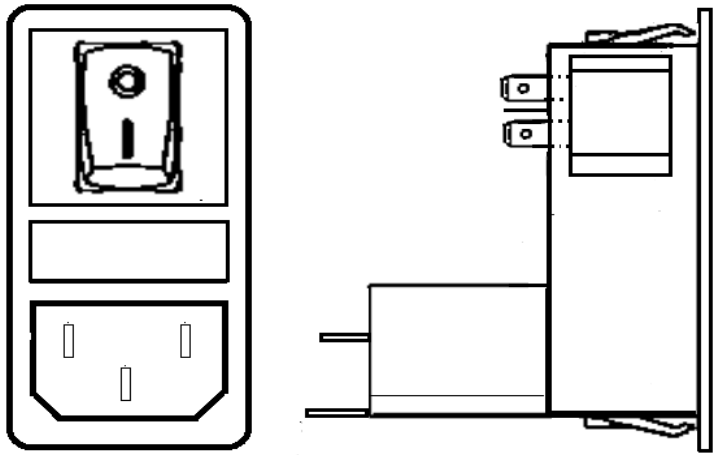

AF-422-3SS

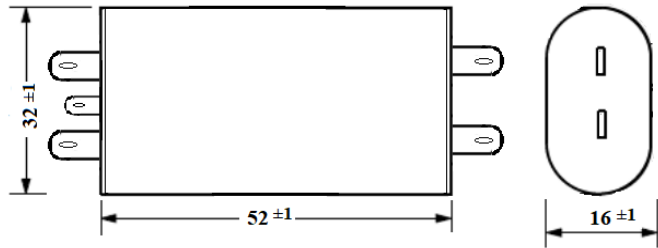

AF-612-10SS

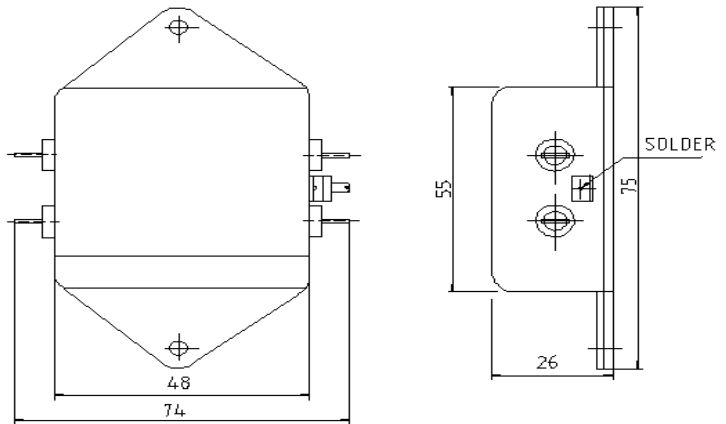
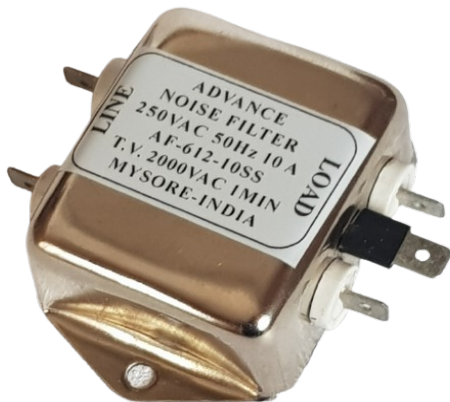

AF-612-5

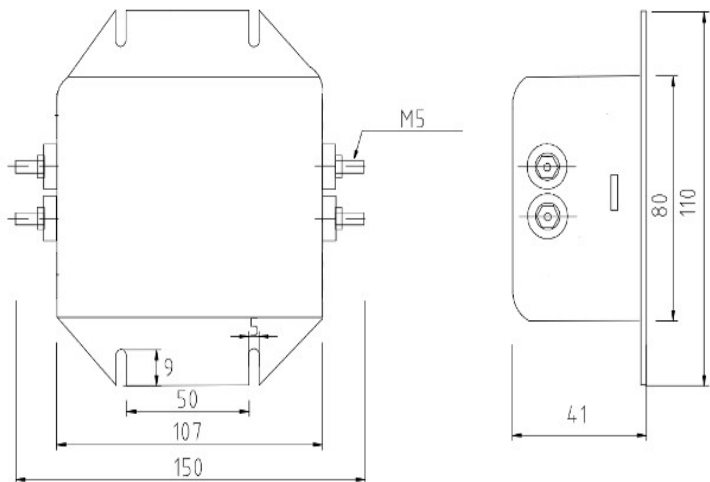

Typical Graphs

Insertion Loss, AF-422-3SS

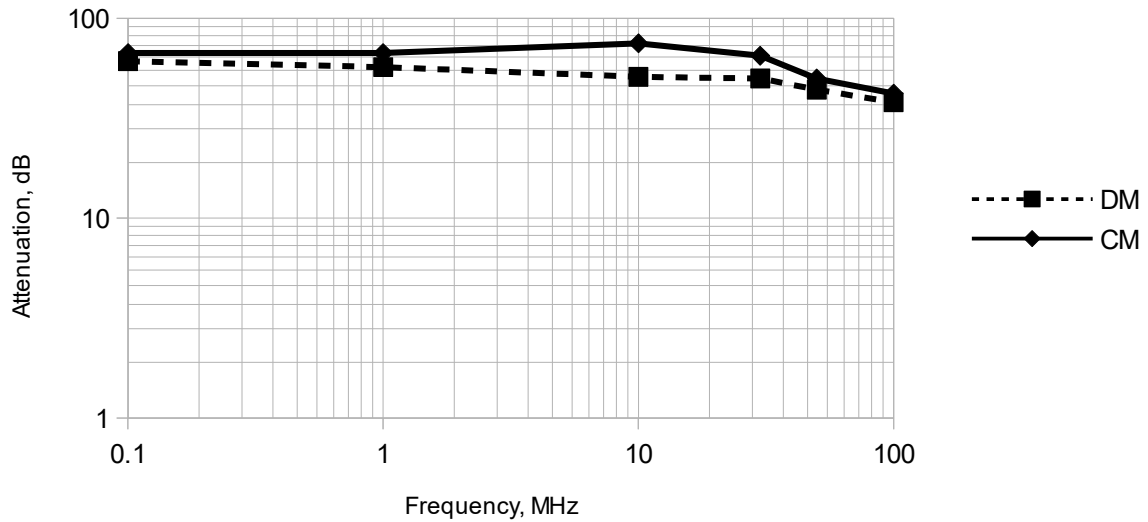

AF-110-3

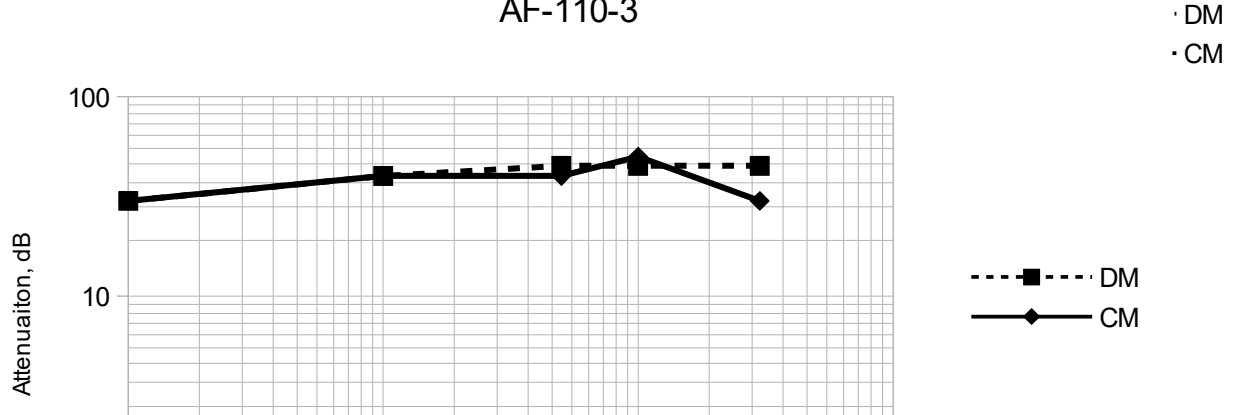

AF-612-10SS

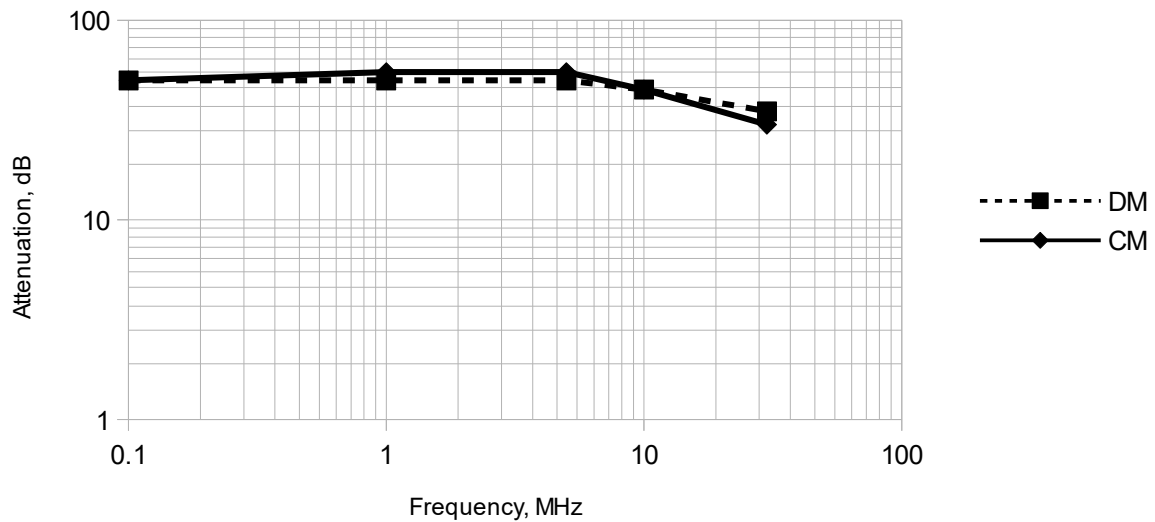

ADVANCE EMI / RFI FILTERS

INTRODUCTION:

Rapid changes of current cause generation of Radio Frequency Interference (RFI) noise. This may be due to Electronic switching such as Oscillators, SMPS, Triac Switches or Electromechanical switches such as commutators or Slip rings. Interference appearing across the line is called Differential Mode and the one appearing across the line to earth is called Common mode Interference. The RFI range covers the spectrum from 150KHz to 300MHz while the ElectroMagnetic Interference (EMI) covers from 10KHz to 10GHz.

APPLICATIONS :

RFI/EMI filters are used to reduce or to eliminate the unwanted RFI noise from entering or leaving the equipment. The suppression is carried out by connecting an inductance (High impedance to RF) in series or a capacitance (low impedance to RF) to ground. The ability of a filter to eliminate the noise is measured in terms of Insertion Loss (in dB) over a frequency spectrum. The RFI filters are used in Office Equipment, Communication Equipment, Instruments, Medical Instruments, SMPS, Computer peripherals, Thyristor Drives and Defence equipment.

SELECTION

The major parameters to be considered during the selection of a filter are :

Rated Voltage, Rated Current, RF noise spectrum, Level of suppression, Grounding arrangement and the leakage current.



Registered Office and Factory:

Advance Components and Instruments Pvt Ltd

3A-3A/1, Belavadi Industrial Area ,Mysore – 570018 KARNATAKA

Phone: +91 821 2402301 / 2402307 /2403058

Mobile & WhatsApp: +91 8073111025

E-mail : advcaps@gmail.com / enquiries@advancecapacitors.com

Website: www.advance-capacitors.com

ADVANCE EMI / RFI FILTERS

General Specifications:

Rated Voltage : 415 or 440Vac 50/60Hz
Rated Current @25°C : As specified in chart (Page #3)
Related Standards : VDE0565-1,2,3, BS2135, UL1283
IEC384-14, IEC939-1,1 JSS53900

Routine Tests

Electrical : Coils: Inductance +50%-30% (VDE 0565-03)
Capacitance: Cx: ±20% (IEC 384-14 X2)
Capacitance: Cy: ±20% (IEC 384-14 Y)
Attenuation : (IL in dB) as specified in drawing

Dielectric Strength : 1500Vac 50Hz for 1 minute (terminals to case)
1075Vdc for 1 second (terminal to terminal)
Insulation Resistance : Between terminals shorted and case
Min.1000MΩ at 500Vdc

Type tests

Voltage drop : Less than 1.5Volts at full load
Temperature Rise : at full load, less than 60°C above 25°C
by resistance method

Environmental

Temperature Cycling : JSS50101-Test 20
Life : JSS50101-Test 13, 250 hours
Damp Heat : 45°C 95% RH 500 hours

All electrical parameters (including Insertion loss) to be checked after the completion of the test.
All parameters to be within the initial specifications.

Resistance to Chemicals : Unit covered with black Toner in a chamber at 45°C for
120 hours. Toner should not stick to the surface.

ADVANCE EMI / RFI FILTERS

ADVANCE Product Range:

Advance product range covers the full spectrum of RFI and EMI upto 1GHz, for DC or AC power line Voltages, from 1A to 400A current range. Various mounting arrangements such as clamp, PCB type, Flange, Bottom stud and various terminal arrangements are available. Integral socket type filters are also available.

Three (3) Phase 415 / 440Vac Filters (3 wire or 4 wire terminals)

Type	Rating in Amperes	Packing, size in mm
AF-355-15	15A	40*80*104 Metal box with screw terminals
AF-355-30	30A	40*80*104 Metal box with screw terminals
AF-355-40	40A	40*80*104 Metal box with screw terminals
AF-355T-16	16A	80*100*150 Metal box with screw terminals
AF-355-50	50A	80*100*150 Metal box with screw terminals
AF-355-55	55A	90*140*240 Metal box with safe touch terminals
AF-355-60	60A	80*100*150 Metal box with screw terminals
AF-355-100	100A	80*100*150 Metal box with screw terminals
AF-355-120N	120A	160*300x95 Metal box with screw terminals

AF-355T-16

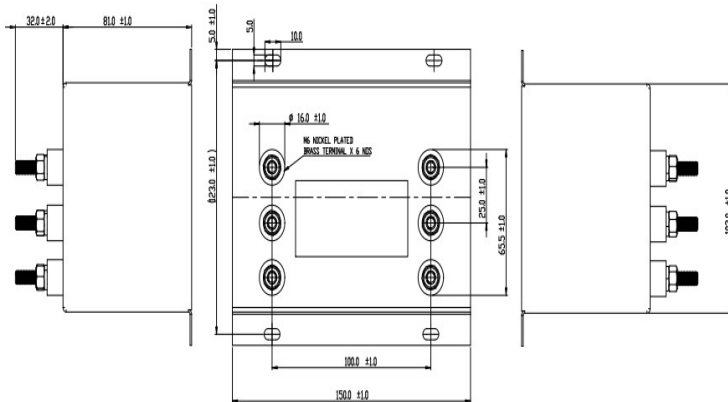

AF-355-55

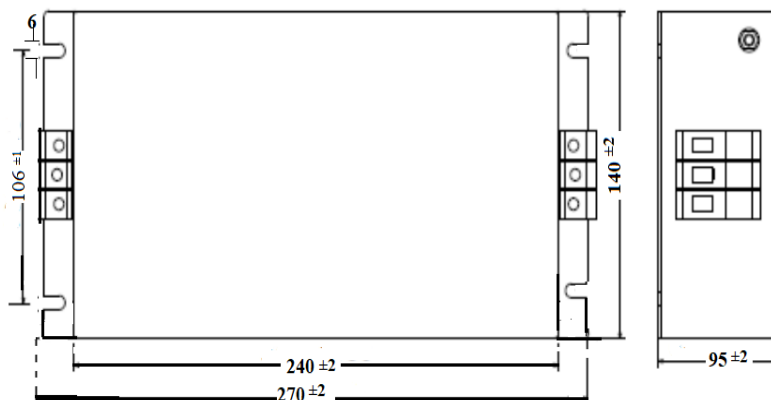

AF-355-50

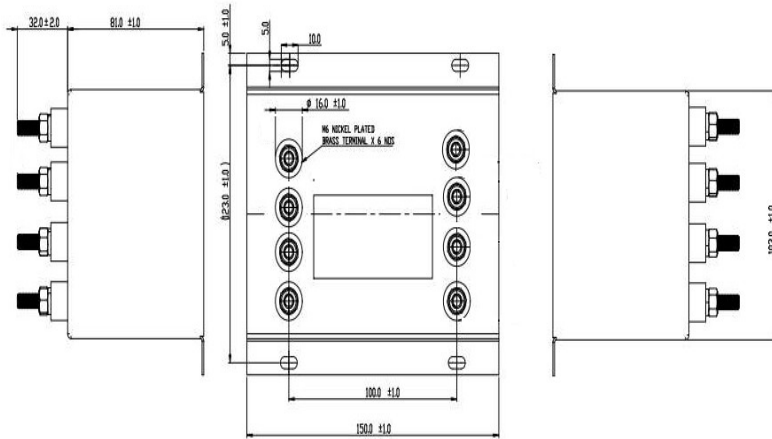

AF-355-120N

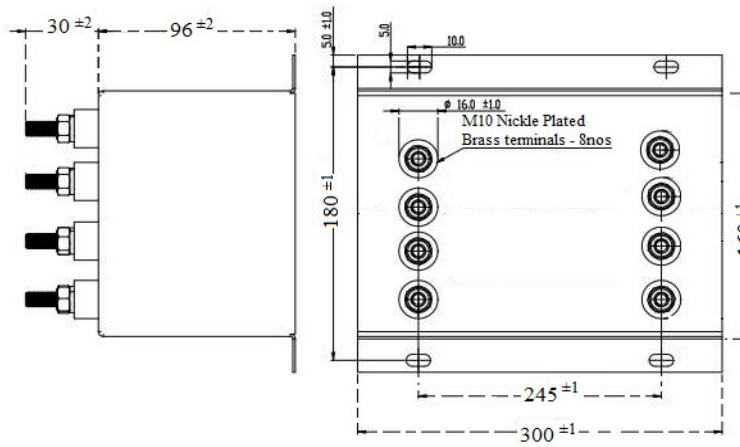

Typical Graphs

Insertion Loss, AF-355-55

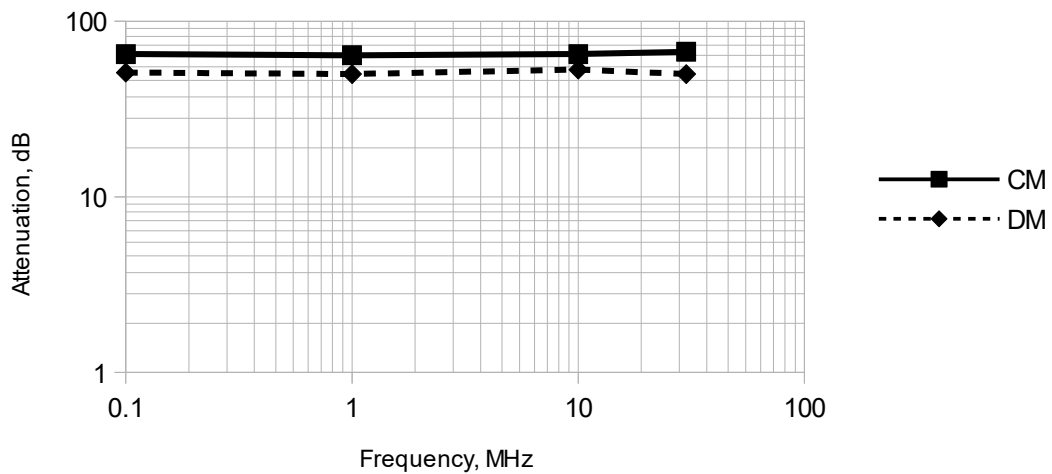

AF-355T-16

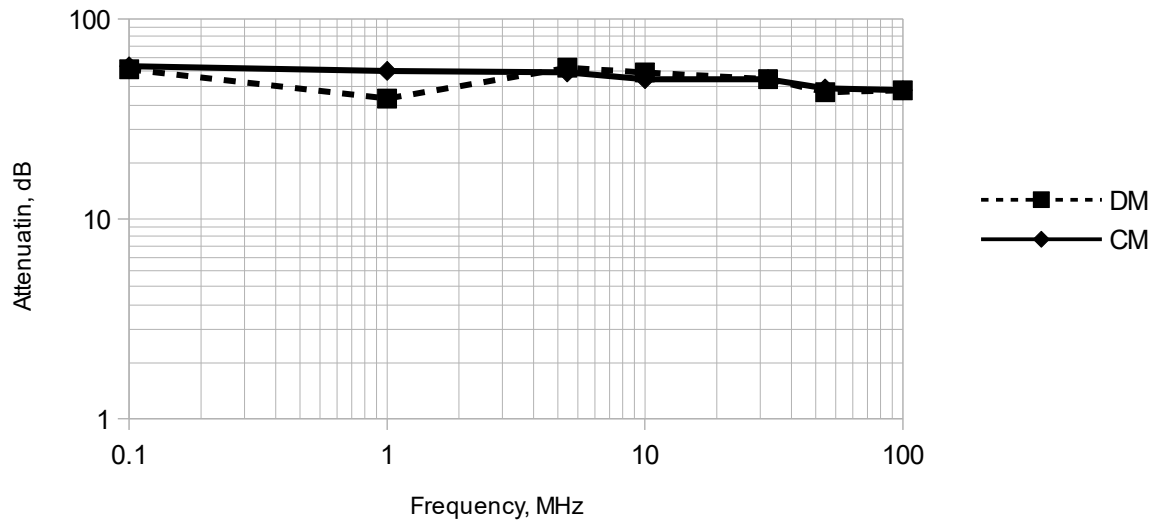

Insertion loss, AF-355-120N

